

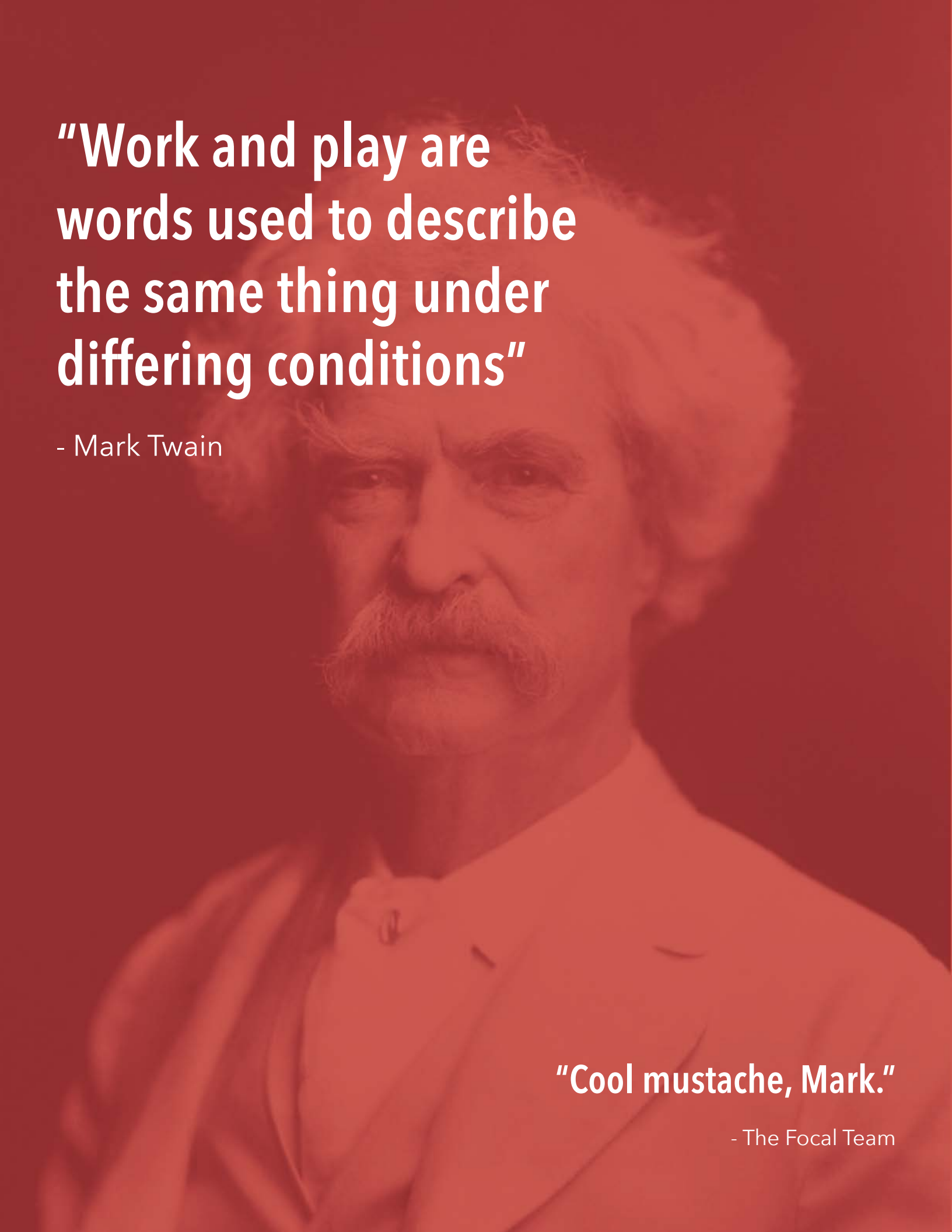

FOCAL UPRIGHT CATALOG

2016





“Work and play are words used to describe the same thing under differing conditions”

- Mark Twain

“Cool mustache, Mark.”

- The Focal Team

TABLE OF CONTENTS

| | |
|-----------------------------|----|
| Introduction | 4 |
| Ergonomic Philosophy | 8 |
| Awards + Recognition | 10 |
| Focal Upright in Your Space | 12 |
| Seats | 14 |
| Desks | 24 |
| Tables | 30 |
| Accessories | 34 |
| Bundles | 40 |

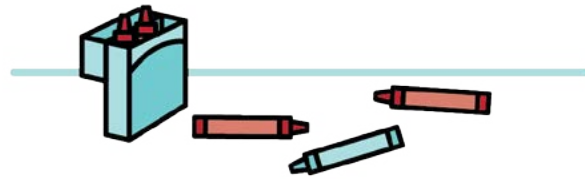

Remember when you were a little kid and dreamed of growing up and working in a cubicle? ...Probably not.

Yet, so many of us spend our days stuck in cramped cubicles, unengaged by our work and our workspaces. Focal Upright exists to shake up the established office order, making work more like you dreamed about when you were a kid. Energizing. Imaginative. Dare we say fun?

How do we do this? By designing movement and play into everything we do.

Our mission is simple:

ENCOURAGE PEOPLE AND COMPANIES TO
MAKE WORK PLAY.

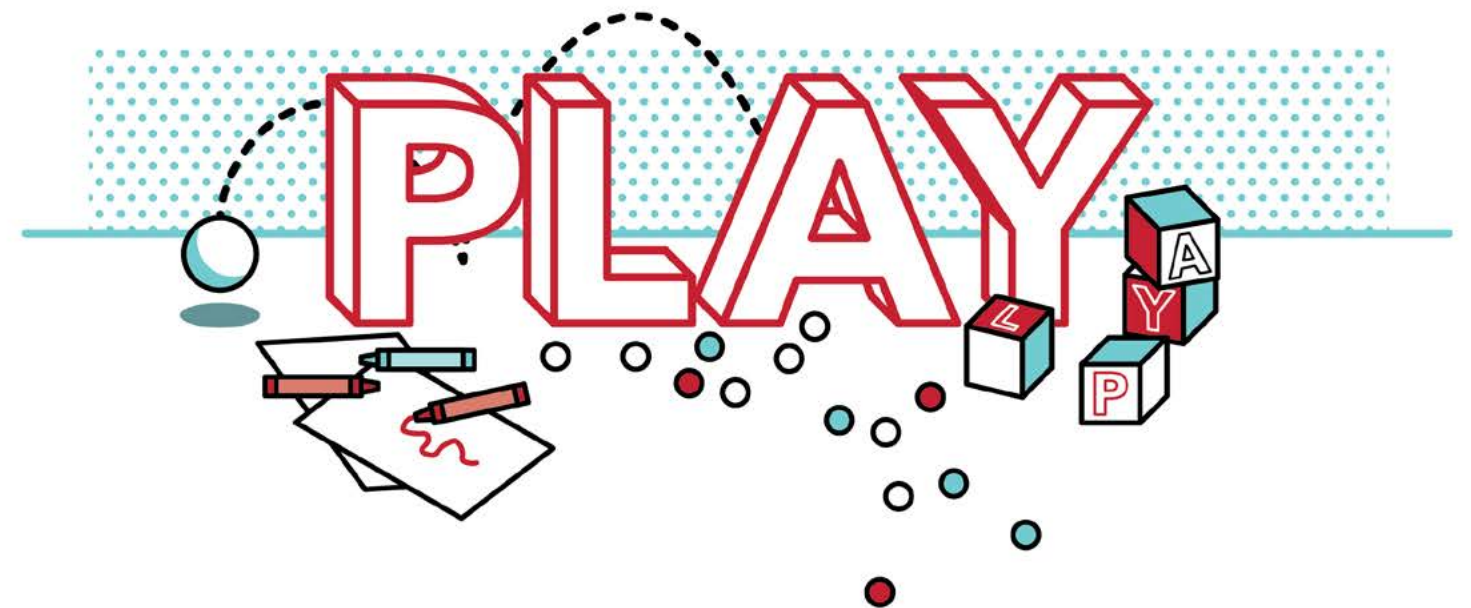
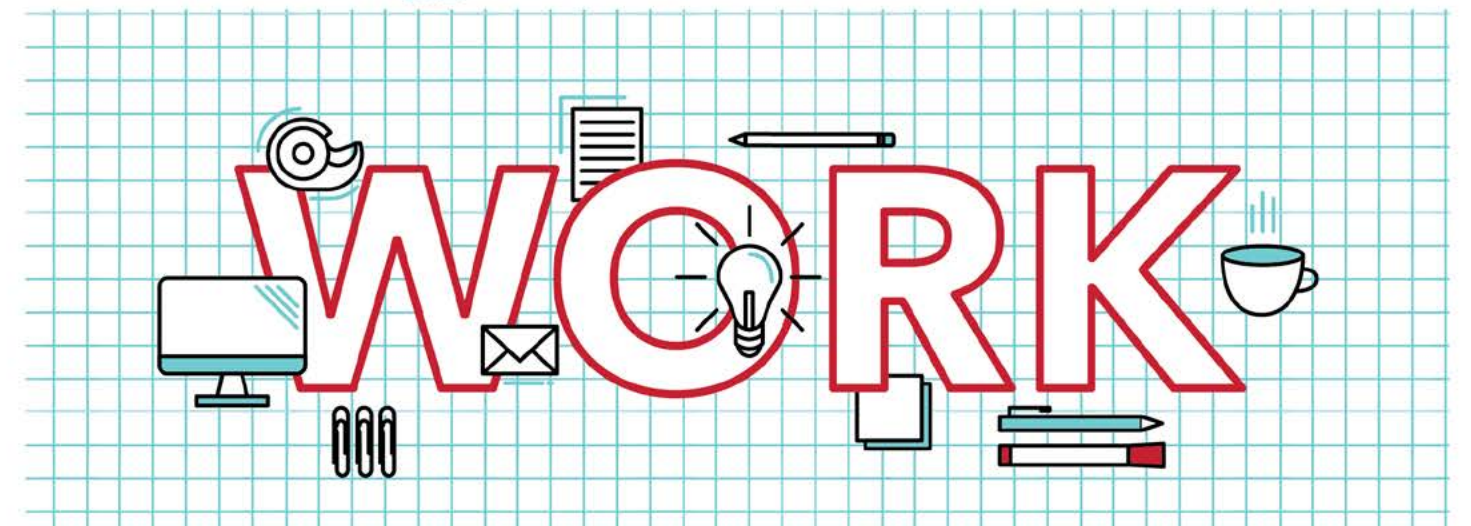



NOT YOUR AVERAGE FURNITURE COMPANY

Focal Upright is turning the ergonomic furniture industry on its head by creating products that work *with* your body. Crazy, right? Not really... Our active seats and standing desks empower you to be free both mentally and physically.

What makes Focal Upright different? Let us count the ways.



POSTURE:

Our products promote a third posture: not sitting, not standing, but a healthy in-between lean that actually works for your body. It's like Goldilocks and the Three Bears for the office. Sitting is too sedentary. Standing is too uncomfortable. Leaning is just right.



MOVEMENT:

Sitting down all day sucks... the energy from your body and the creativity from your brain. Focal Upright products keep you moving and grooving, so you can stay physically and mentally engaged all day long.



DESIGN:

Our products have a bold design that gets people talking. All Focal products have a stripped-down, modern aesthetic that balances functionality and fun. Your coworkers will be instantly jealous of your new set-up. Trust us.



ATTITUDE:

Let's face it... Most office furniture is pretty lame. But Focal Upright isn't most office furniture. Our products are packed with personality and designed to inject playfulness into any space.

ERGONOMIC PHILOSOPHY

Exercise balls. Hacked standing desks. Even treadmill desks. Disgruntled desk jockeys have tried all these quick fixes in an effort to beat sitting disease. Here's the problem: these solutions are not sustainable.

Focal Upright's products break the sit-stand dichotomy, giving people a third posture that actually works with your body. The lean, as we like to call it, balances the active benefits of standing with the comfort of sitting.

The leaning posture encourages a hip to torso angle between 130 and 135 degrees. Researchers have determined that this posture puts the least amount of stress on your spine and its connecting muscles. In fact, when astronauts float in zero gravity, they naturally assume the same open-hip posture. (By the way, NASA says our seats are out of this world.)

What's more, Focal Upright's products keep you moving and grooving so you get all of the benefits of non-exercise activity thermogenesis (NEAT) – boosted energy, improved circulation, and enhanced core engagement to name a few.





AWARDS + RECOGNITION

We believe we're a cut above the rest. But don't just take our word for it; Focal products are award winners time and time again.



2015 GOOD DESIGN Award
Chicago Athenaeum
Sphere Workstation



2014 NeoCon Product
Innovations Grand Prize in
the Seating Category by
Buildings Magazine
Mobis Seat



2014 ErgoExpo
Attendees' Choice Award
Confluence Table



2014 Inc. Best in Class
Design Award
Sphere Workstation



2013 NeoCon Product
Innovations Grand Prize
Award (furniture systems) by
Buildings Magazine
Locus Workstation



2012 ErgoExpo
Attendees' Choice Award
Locus Workstation



FAST COMPANY

MY YEAR AT A STANDING DESK AND WHY I'LL NEVER GO BACK

"It all started with a bet.

I came into the Fast Company office one April morning last year and crafted a makeshift platform for my laptop and secondary monitor from discarded Ikea side tables so I could try standing while I worked.

People were naturally curious when they saw my new setup and started to bet that I wouldn't last at my new standing desk for more than three months. Trash-talking ensued and money and offers for dinner were promised.

It was on. I had to stay standing just to prove everyone wrong."

Inc.

10 WAYS TO REJUVENATE
YOUR BRAIN WHILE YOU
WORK

"Focal Upright Furniture has a brand-new chair-and-desk combination on the market. Invented by Martin Keen, of Keen shoes fame, it uses a position between sitting and standing, and allows lots of movement as you work. It also helps those who use it remain attentive."

BUSINESS INSIDER

I JUST FOUND THE
PERFECT SOLUTION TO
STANDING DESK FATIGUE
AT SXSW

"Since converting [to a standing desk], I've fallen in love with my standing situation... But there is one major problem: When I do want to sit, there's no comfortable way to do it..."

During a jaunt through the SXSW exhibition center early today, though, I stumbled upon the perfect solution. It's called the 'Mogo portable seat' and it's made by a company called Focal Upright."

THE WALL STREET JOURNAL

THE ECONOMICS OF
ERGONOMICS

"Office workers have been warned about the dangers of sitting. Focal Upright Furniture CEO Martin Keen discusses how his chairs may improve posture and health."

FOCAL UPRIGHT IN YOUR SPACE

Conventional standing desk wisdom optimizes for individual workstations, allowing workers to customize their space for an active workspace. But to create an active office culture, you must address all aspects of the office.





As established by Ikujiro Nonaka and Hirotaka Takeuchi in *The Knowledge-Creating Company*, and more recently supported by Gensler's research on workplace productivity, there are four essential modes of building knowledge that drive creativity and innovation; socializing, focusing, learning, and collaborating. When applied to opportunities within a working culture, these modes help create well-balanced individuals and encourage innovation.

We take this ideology one step further. By creating work zones that reflect these four modes, we bake knowledge building into the core of a company's culture.

With leaning seats and standing-height workstations, the effects are heightened. You get faster, more efficient collaborations when standing at the Confluence, as opposed to slumped in the boardroom chair. You focus better when your body is activated by the Locus Seat. You learn more when you can fidget naturally on the Mobis Seat with the Stabilizing Foot Rest, rather than being distracted by your discomfort.



WORK ZONES KEY

| | |
|--|--|
|  <p>SOCIAL Informal interactions that foster relationships among coworkers.</p> |  <p>FOCUS Allows workers to concentrate on a specific task without distractions.</p> |
|  <p>LEARNING Opportunities for knowledge building, or exploring ways to improve on what's already happening.</p> |  <p>COLLABORATION Bringing individuals together to achieve one goal.</p> |

SEATS



You don't settle. Neither should your office seat. Try a seat that's as innovative and revolutionary as you; for one, it's not a chair.



LOCUS SEAT

The Locus Seat is a rebel with a cause. It rejects both the design of the traditional chair and the notion that you have to be sitting down to get serious about your work. Why? Because you deserve to feel great at work, and your current office chair is letting you down.

You don't sit on the Locus Seat; you lean into it. When you do, your body is supported in a neutral posture that will have you saying, "Ahh..."

This award-winning ergonomic seat is radically responsive; it's designed to adjust to every move you make. As you work your body becomes effortlessly active. Your spine relaxes. Your major muscles engage. Your circulation increases. You get the comfort of sitting with the activity of standing. Pretty good combo, if we do say so ourselves. Already a standing desk user? Good news. The Locus Seat pairs perfectly with most standing desks or height-adjustable workstations, so you can easily upgrade your existing standing desk set-up.

The Locus Seat includes Focal's Anti-Fatigue Mat, which is designed to add an extra layer of comfort to your Locus Seat. The Anti-Fatigue Mat takes stress off your feet and ankles so you can work comfortably for longer stretches of time.

FEATURES

- American-made wood base adjusts to accommodate most users' heights
- Discreetly designed wheels for easy portability
- Pivoting seat leg encourages dynamic movement
- Seat pan tilts up to 5 degrees to support hip flexibility
- Non-slip, easy-to-clean contoured seat cushion reduces pressure points
- Post folds for easy storage



SPECS

| | |
|---------------------------|--------------------------|
| Shortest Position | L 37" x W 25.5" x H 31" |
| Tallest Position | L 45" x W 25.5" x H 41" |
| Storage or Transportation | L 37" x W 25.5" x H 8.3" |

SEAT BASE FINISHES

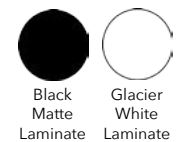

SEAT CUSHION FINISHES



MAKE IT A BUNDLE

Pair the **Locus Seat** with any of our standing desks for a fully tricked out workstation. For more info on bundles, see pages 40.

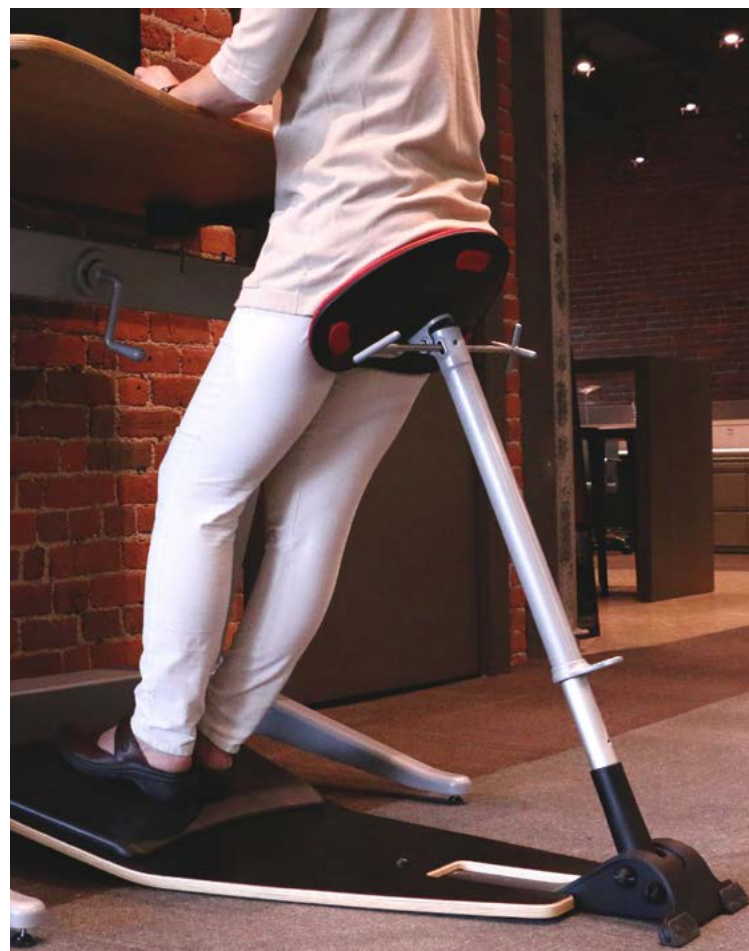



MOBIS SEAT

Mobis is an ergonomic task seat with attitude. Stripped of the conventional trappings of office chairs, Mobis's minimalist design actually works with your body. Mobis offers the ideal level of healthy support for your body, keeping your spine in a neutral posture and your major muscles engaged. Crazy, right?

How does it work? Mobis won't stand for slouching! It gently enforces good posture by returning your spine to its healthy S-curve. And, because the seat's angled design encourages movement, both your body and your brain stay engaged.

Mobis pairs perfectly with any standing desk or height-adjustable workstation. It's smart, space-saving design is also ideal for meeting spaces, encouraging spontaneous collaboration and aha moments.

FEATURES

- Ellipse-shaped base with non-slip rim provides stability for active postures
- Pivoting seat leg encourages dynamic movement
- Easy-adjust handles to lift and lower the seat
- Non-slip, easy-to-clean contoured seat cushion reduces pressure points
- Built-in handle for easy portability



SPECS

| | |
|----------------|-------------|
| Height | 25-35" |
| Base Footprint | 16" ellipse |
| Weight | 15 lbs |

SEAT CUSHION COLORS



MAKE IT A BUNDLE

The Mobis Seat is made even more comfortable by our **Stabilizing Foot Rest**. Purchase the pair together as the **Mobis Seat Bundle**. For more information, see page 40.





PIVOT SEAT

Do you like to move it (move it)? Then it's time you met Pivot, our newest, most active leaning seat yet.

The Pivot Seat is a minimalist task seat with serious ergo-sensibilities. Unlike most chairs that feebly acquiesce as your posture deteriorates into a sluggish slump, the Pivot Seat keeps you active.

The Pivot Seat's weighted base is built with active stability, so it responds to every move you make. The seat's Rubber Octogrip Overmold provides just enough friction so you have full freedom of motion. It encourages you to twist, turn, swivel and even pivot with ease. Pivot's sleek seat is positioned forward, so that you find your natural equilibrium, engaging your core and mastering perfect posture. What's more, Pivot easily lifts and lowers, empowering you to take a range of healthy postures from active sitting to leaning.

The Pivot Seat is playfully designed. It isn't concerned with expectations. In fact, it flat out rejects most notions of what a seat "should" be. Instead, it was created to work with you, so you can bring more play to your day. Imagine what you can do when you Pivot while you work.

FEATURES

- The weighted base leverages your center of gravity to support various degrees of use, so you can rock (and not roll)
- Rubber Octogrip Overmold enables you to enjoy a full range of motion while maintaining control
- Pivoting seat leg empowers you to move 360 degrees
- Seat pan is cantilevered forward to promote the optimal open hip angle
- Easy-adjust piston-release handles lift and lower the seat, encouraging a range of postures from active sitting to leaning
- Tri-Flex Seat Cushion has built-in sitz bone contours for plush support and a waterfall edge to reduce pressure on the upper legs and promote healthy circulation

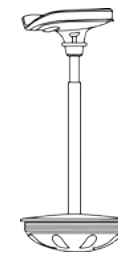

SPECS

| | |
|--------|----------|
| Height | 25-35.5" |
| Width | 13.5" |
| Weight | 25 lbs |

SEAT CUSHION COLORS



MAKE IT A BUNDLE

The Pivot Seat is made even more comfortable by our **Stabilizing Foot Rest**. Purchase the pair together as the **Pivot Seat Bundle**. For more information, see page 40.





MOGO SEAT

Your office chair has serious Mogo envy. It wishes it could be half as clever as Mogo, what with its portability, versatility, and free-wheeling lifestyle. Mogo is the simplest, most supportive portable leaning seat out there.

Find yourself in need a break from standing? Just grab your Mogo, twist on the seat pan, deploy the pivoting leg post, and boom, you have a seat to get your ergonomic lean on. It's seriously that simple.

Mogo works both indoors and out. It will support you at the sideline of the soccer field on a Saturday morning, or relaxing on a warm summer evening at a music festival. Mogo is right at home in the conference room too, making impromptu collaboration sessions easier than ever. At just over two pounds, it is fully collapsible to fit into your tote bag or strap to your backpack.



SPECS

| | |
|------------------------|---------------|
| Fully Retracted Length | 18.5" |
| Fully Extended Length | 38" |
| Seat Dimensions | W 4.5" x L 8" |
| Weight | 2.5 lbs |

SEAT CUSHION COLORS

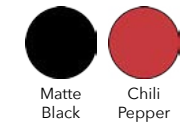

MAKE IT A BUNDLE

The Mogo Seat is made even more comfortable by our **Stabilizing Foot Rest**. Purchase the pair together as the **Mogo Seat Bundle**.



FEATURES

- Soft durometer rubber foot works on non-slip indoor surfaces
- Reinforced-fiberglass turf tip keeps you stabilized on grass, dirt, and turf
- Multiple notches for easy height adjustment
- Pivoting seat leg has an impressive range of motion, encouraging dynamic movement
- Non-slip, easy-to-clean contoured seat cushion reduces pressure points
- Compact, portable design



DESKS



Better health isn't the only reason a standing-height desk is good for you. Find yourself in the flow more often.



LOCUS DESK

Certain things send a message to those around us. With the Locus Standing Desk, the message is clear: "I've got this!" The Locus Standing Desk is smart, confident, and rock solid—just like you.

Never before has a standing desk looked—or felt—this good. The Locus Desk's stripped-down, modern aesthetic will make you the envy of the office (trust us). What's more, the desk packs a serious ergonomic punch, keeping you in an active posture while you work.

How does the Locus Desk work? Glad you asked. The desk lifts and lowers effortlessly with the turn of a precision German hand crank. The American-made desktop adjusts easily too. The desktop pivots from absolutely flat to a 15 degree angle, enabling you to find your perfect working position, whether you are working on a computer or sketching in a notebook. The Locus Desk is now available in 3 desktop sizes, so it's easier than ever to customize your desk to fit your workspace and work style.

FEATURES

- Lightweight and sustainably sourced aluminum legs provide a solid base
- German hand crank effortlessly lifts and lowers the desk
- Natural wood desk top provides an expansive work surface
- Desk top tilts from flat to 15 degrees to accommodate digital and analog work



SPECS

| | Locus 4 | Locus 5 | Locus 6 |
|--------------------|---------------|---------------|---------------|
| Desktop Dimensions | L 30" x W 48" | L 30" x W 60" | L 30" x W 72" |
| Height Adjustable | H 36" - 48" | H 36" - 48" | H 36" - 48" |
| Weight | 90 lbs | 94 lbs | 103 lbs |

DESKTOP SIZES

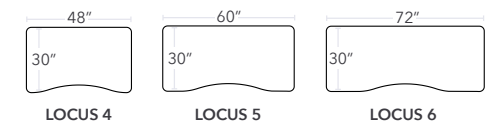

DESKTOP FINISHES



MAKE IT A BUNDLE

Pair the **Locus Desk** and **Locus Seat** for a full leaning workstation by purchasing our **Locus Bundle** (available in all sizes.) For a more tricked out workstation, try the **Locus Bundle Pro**, which includes additional accessories. See page 40 for more info.



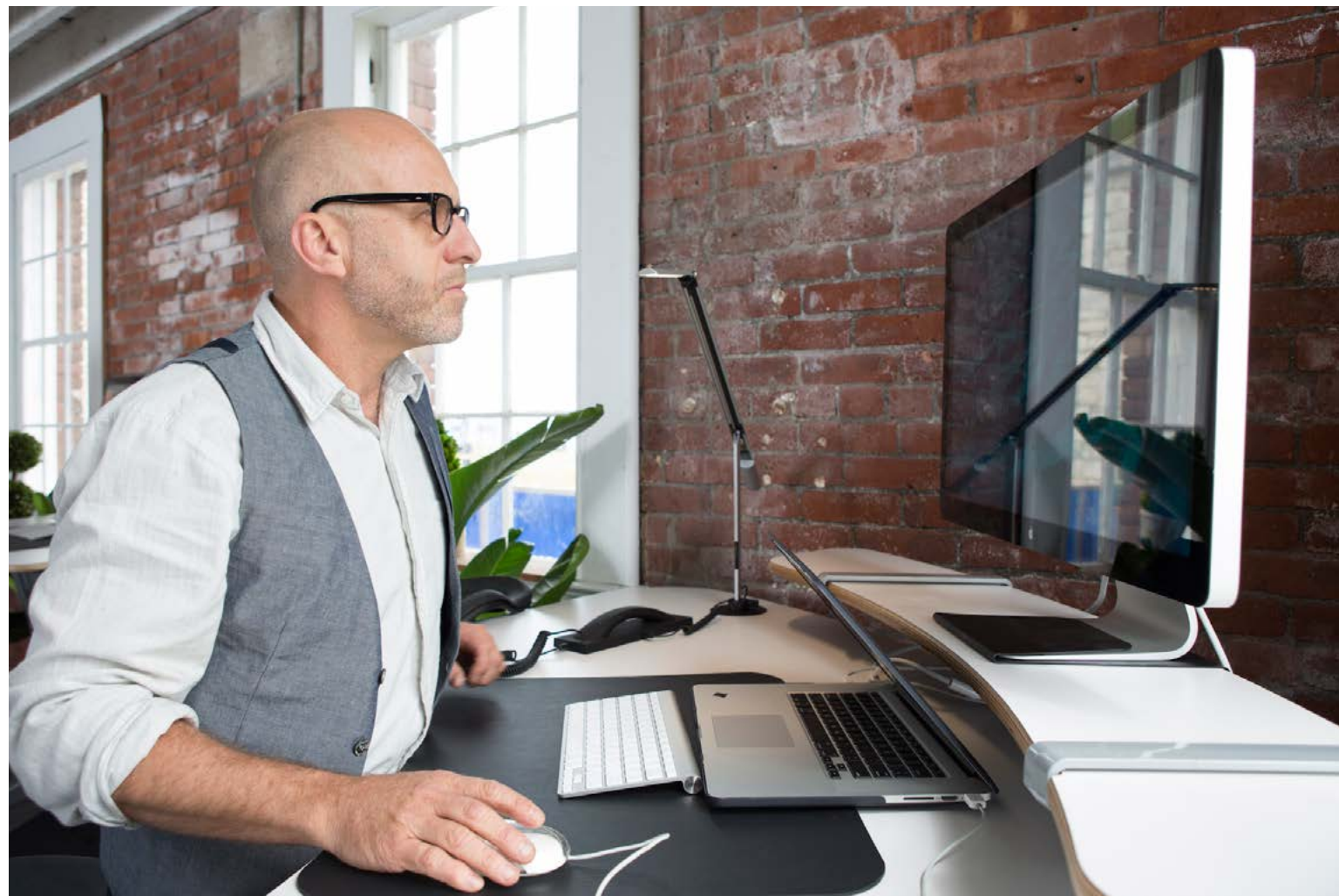

SPHERE DESK

Every time you step into the office, you have something new to conquer. You deserve a standing desk that's equally up for the challenge. Meet the Sphere Desk.

The Sphere Desk is a height-adjustable, angle-adjustable desk designed for the enlightened executive. It's handsomely designed, that's a given. But, it also packs a serious ergonomic punch, keeping you active all day long. Think of it as the Command Center and the Corner Office combined.

The Sphere Desk's spacious desktop maximizes your workspace, giving you even more room to get sh** done. The desk lifts and lowers effortlessly with the turn of a precision German hand crank system. The American-made desktop adjusts easily, too. The desktop pivots from absolutely flat to up to a 15 degree angle, enabling you to find your perfect working position.



SPECS

| | |
|--------------------|-----------------|
| Desktop Dimensions | L 27.5" x W 78" |
| Height-adjustable | H 36" - 48" |
| Weight | 95 lbs |

DESKTOP SIZE

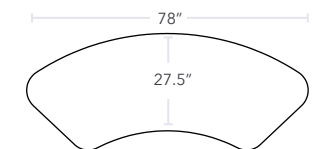

FEATURES

- Lightweight and sustainably sourced aluminum legs provide a solid base
- German hand crank effortlessly lifts and lowers the desk
- Natural wood desk top provides an expansive work surface
- Desk top tilts from flat to 15 degrees to accommodate digital and analog work

DESKTOP FINISHES

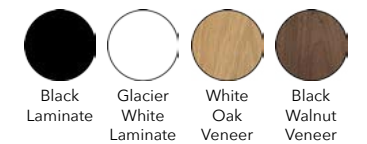

MAKE IT A BUNDLE

Pair the **Sphere Desk** and **Locus Seat** for a full leaning workstation by purchasing our **Sphere Bundle** (available in all sizes.) For a more tricked out workstation, try the **Sphere Bundle Pro**, which includes additional accessories. See page 40 for more info.

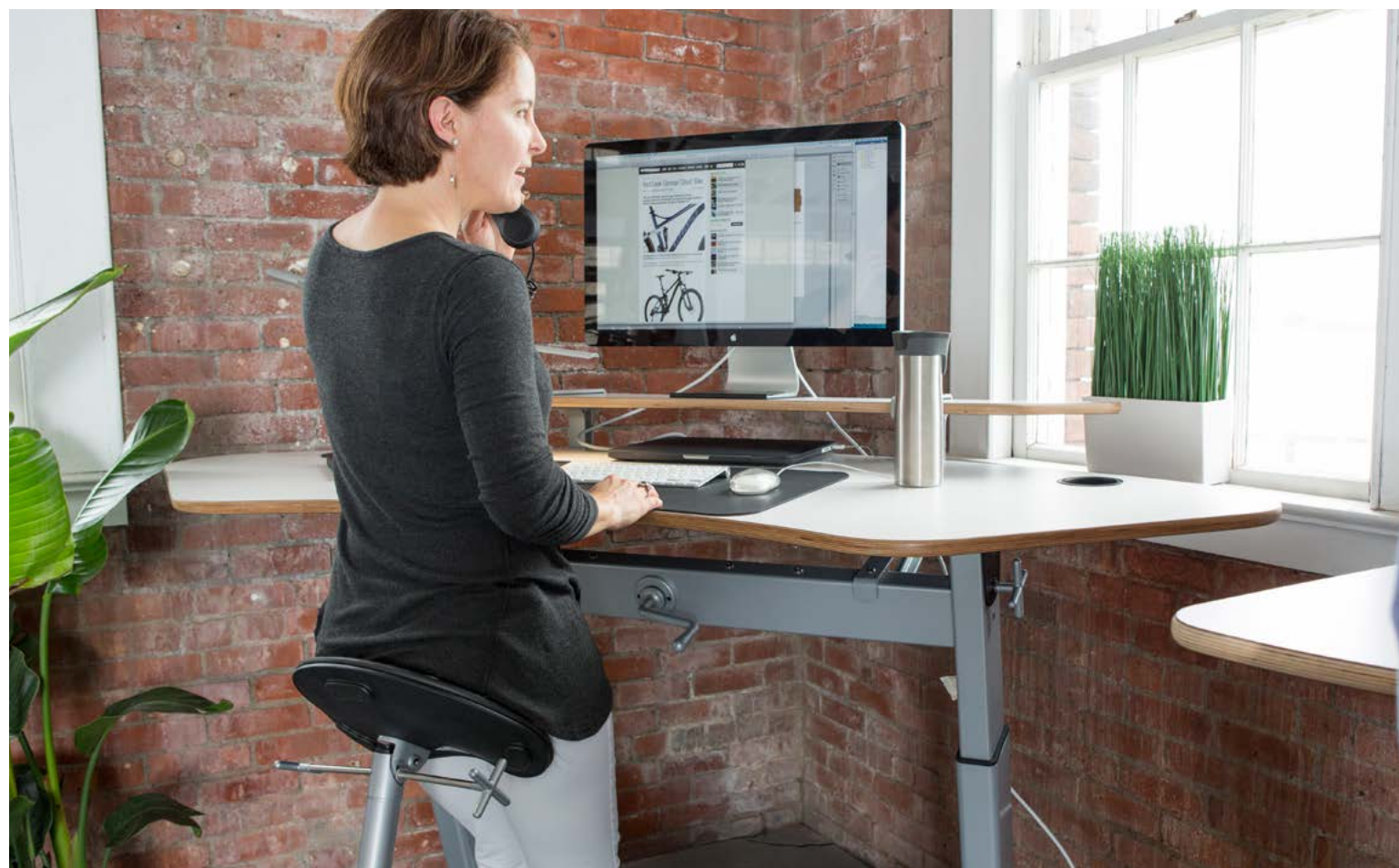



Teamwork at every turn. With a standing-height Confluence table, collaborating is easier than ever.

TABLES



CONFLUENCE TABLE

Bad news: most meetings are serious snoozefests. Good news: they don't have to be.

What's the secret to shorter, more productive, more creative collaboration sessions? No more chairs. (Yes, you read that correctly!)

Your meeting space sets the tone for your meeting. Ditch your passive conference room set-up and huddle up around Confluence, the active standing-height conference table instead.

The Confluence Table is an adjustable-height conference table that acts as an energy boost for your team. The tabletop effortlessly glides up and down by turning the small hand crank on the desk's frame. A foot rest bar provides extra comfort while standing or using a Focal Upright seat. The design is effortlessly sleek, modern and agile. What's more, the Confluence Table naturally takes up less space than your average conference room table, so you can squeeze even more collaboration space into your office. Don't need adjustable-height functionality? Try our 40" fixed height option.

Bring all of the benefits of standing desks to the conference room with Confluence.

FEATURES

- Lightweight and sustainably sourced aluminum legs provide a solid base
- Sleek foot bar allows users to rest feet
- Height adjustable option includes a German hand crank which effortlessly lifts and lowers the desk
- Slim tabletop design maximizes space



SPECS

| | Confluence 6 | Confluence 8 |
|--------------------------|---------------|---------------|
| Tabletop Dimensions | L 78" x W 34" | L 94" x W 36" |
| Height-adjustable Option | H 36" - 48" | H 36" - 48" |
| Fixed-height Option | H 40" | H 40" |

HEIGHT ADJUSTABILITY

The Confluence is available in two sizes, as well as two models: **height-adjustable** or **fixed-height**.

Height-adjustable: Includes an easy crank so you can raise or lower the height based on your team's preference.

Fixed-height: Set at a comfortable 40", the fixed-height option is ideal for quick moving teams who don't need the flexibility of the height adjustment.

TABLETOP SIZE

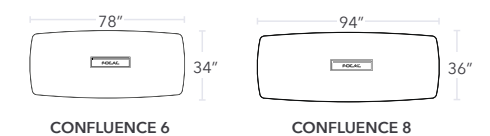

TABLETOP FINISHES





ACCESSORIES

Personal differentiation is everything. Why should your desk be any different? Individualize your workspace with Focal accessories.

STAY FLAT SHELF

The Stay Flat Shelf provides a level surface, even when the desk is at full tilt. It keeps your water bottle, papers, and knicknacks in place. The shelf is made of furniture grade plywood and is attached with cast aluminum and silver powder-coated brackets.

Available for all sizes of Locus Desk and the Sphere Desk.

SPECS

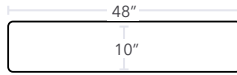
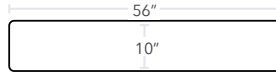
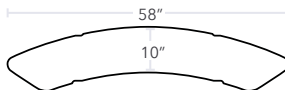
| Dimensions | Weight | Compatibility |
|--|--------|-------------------------|
| LOCUS 4 SHELF | | |
|  <p>L 48" x W 10" x H 0.75"</p> | 20 lbs | Locus 4 Desk |
| LOCUS 5/6 SHELF | | |
|  <p>L 56" x W 10" x H 0.75"</p> | 22 lbs | Locus 5 or Locus 6 Desk |
| SPHERE SHELF | | |
|  <p>L 68" x W 10" x H 0.75"</p> | 22 lbs | Sphere Desk |

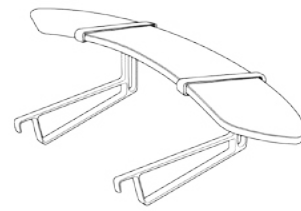

FEATURES

- Empowers you to mount your monitor at the ergo-recommended height
- Easy installation, bolts to the desk's upper stretcher
- Keeps your monitor steady, even when your desk is tilted

SHELF FINISH OPTIONS



STABILIZING FOOT REST

The Stabilizing Foot Rest makes it easier than ever to get the foot support you need. It takes pressure off your feet, enabling better circulation and less foul language.

How does it work? Glad you asked. The simple action of placing your feet on the Stabilizing Foot Rest takes pressure off your foot bones, provides much-needed ankle support, and promotes circulation in your lower body. Additionally, the Stabilizing Foot Rest allows you to keep moving throughout the workday, encouraging you to vary postures while you work.

The Stabilizing Foot Rest can be paired with standing desks and traditional seated workstations. It is even better when paired with the Mobis and Mogo, taking pressure off the front of your feet so you can work comfortably all day long.

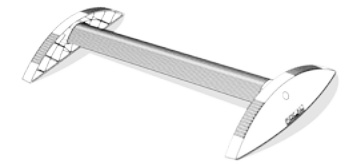

SPECS

| | |
|------------|------------------------|
| Dimensions | L 26" x W 14" x H 3.5" |
| Weight | 3 lbs |

FEATURES

- Non-slip design keeps the foot rest in place on hard and soft surfaces
- Raised ridges provide extra comfort
- Sleek and unobtrusive design
- Pairs with any standing desk

LED WORK LIGHT

The LED Work Light by Konzept is best-in-class, incorporating style, elegance, and environmentally friendly features. The lamp has a streamlined counterweight design for feather-light adjustability. One finger is all you need to adjust the floating arm's position, and the tilting head stays positioned when the arm is raised or lowered. Never has it been this easy to properly light your workspace.

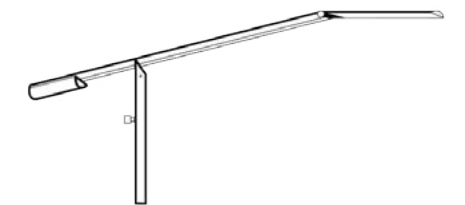

SPECS

| | |
|------------|-----------------------------|
| Dimensions | L 32" x W 1.25" x H 7.5-29" |
| Weight | 6 lbs |

FEATURES

- Feather light touch adjustability
- Delicate counterbalance design keeps the LED head at any angle
- LEDs rated for 50,000 hours of use - that's 8 hours a day for 17 years

CABLE MANAGEMENT TRAY

You've tidied all of your errant papers. You've gathered all of your wayward pens. You are starting to feel the magic of tidying up! But wait, you see them. All of your nagging chords and cables hanging from your desk, ruining your pristine workspace.

Not anymore. Meet the Cable Management Tray.

The Cable Management Tray liberates you from all that cable clutter. Made of powder-coated bent steel, the cable management tray keeps all of your cables tidy and organized. It seamlessly bolts on to the upper stretcher of any Focal desk.

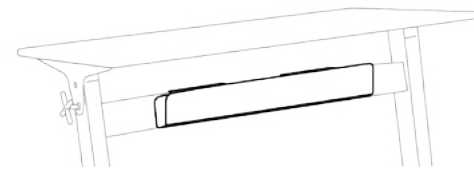

FEATURES

- Easy installation
- Pairs with any Focal standing desk
- Tucks messy cords out of sight



ANTI-FATIGUE MAT

The Anti-Fatigue Mat is designed to add an extra layer of comfort to your Locus Seat, taking stress off your feet and ankles so you can work comfortably for longer stretches of time.

The Anti-Fatigue Mat is designed for durability; it won't delaminate, curl, compress, or wear through. What's more, the mat is easy to clean. Spritz it with any household cleaner, wipe it with a damp cloth, and you're good to go.

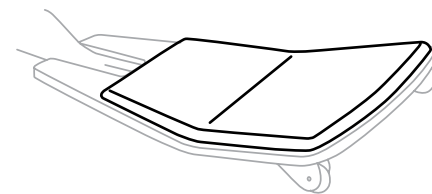

FEATURES

- Goldilocks level comfort: not too soft, not too hard, just right
- Flexible, easy-to-clean material is naturally resistant to mildew and microbial growth
- One piece construction for long-lasting durability
- Pairs with any standing desk



IMAC BRACKET

The iMac Bracket keeps your monitor in place simply and securely. The powder-coated bent steel device can be placed directly onto the Locus or Sphere Desk or attached to the Stay Flat Shelf and works with iMac computers, Thunderbolt and Cinema displays.

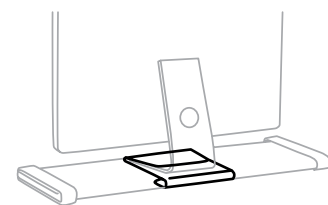

FEATURES

- Compatible with iMac computers, Thunderbolt and Cinema displays. Sleek, modern design
- Easy install
- Pairs with any Focal desk



BUNDLES



Our products are impressive on their own. But with our desk and seating bundles, your office is sure to be even more active, comfortable, and tricked out than before.



DESK BUNDLES

1. CHOOSE YOUR DESKTOP

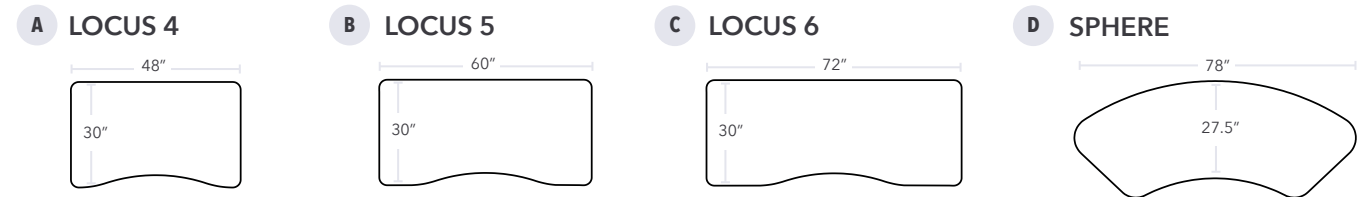

2. CHOOSE YOUR FINISH



3. CHOOSE YOUR BUNDLE PACKAGE

| BUNDLE | OR | BUNDLE PRO |
|--------|----|------------|
|--------|----|------------|

Stay upright all day long with our basic Bundles. With your choice of desktop, you can create the bundle best suited for your workspace and work style. And our Locus leaning seat will keep you active and upright.

The Bundle includes:

- + Desktop shape and finish of your choice
- + Locus Leaning Seat with a matte black seat base and black seat cushion
- + Anti-Fatigue Mat



The Bundle Pro goes above and beyond the normal workstation. From the professional black nubuck seat cushion to the sleek Cable Management Tray, every accessory has been thoughtfully selected to help optimize your workspace.

The Bundle Pro includes:

- + Desktop shape and finish of your choice
- + Locus Leaning Seat with a matte black seat base and black nubuck seat cushion
- + Anti-Fatigue Mat
- + Stay Flat Shelf
- + LED Work Light
- + Cable Management Tray

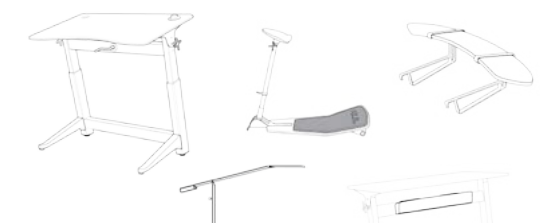



SEAT BUNDLES

1. CHOOSE YOUR SEAT

A MOBIS SEAT



B PIVOT SEAT

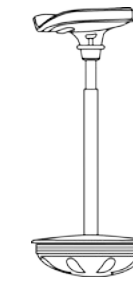

C MOGO SEAT



2. CHOOSE YOUR SEAT COLOR

A MOBIS SEAT



B PIVOT SEAT



C MOGO SEAT



3. ADD THE STABILIZING FOOT REST

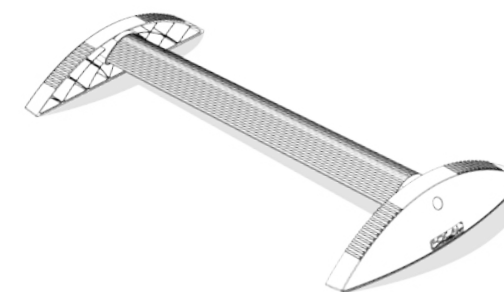

The Stabilizing Foot Rest makes it easier than ever to get foot support you need.

How does it work? The simple action of placing your feet on the Stabilizing Foot Rest takes pressure off your foot bones, provides much-needed ankle support, and promotes circulation in your lower body. Additionally, the Stabilizing Foot Rest allows you to keep moving throughout the workday, encouraging you to vary postures while you work.

The Stabilizing Foot Rest can be paired with standing desks and traditional seated workstations. It is even better when paired with the Mobis, Pivot, or Mogo, taking pressure off the front of your feet so you can work comfortably all day long.

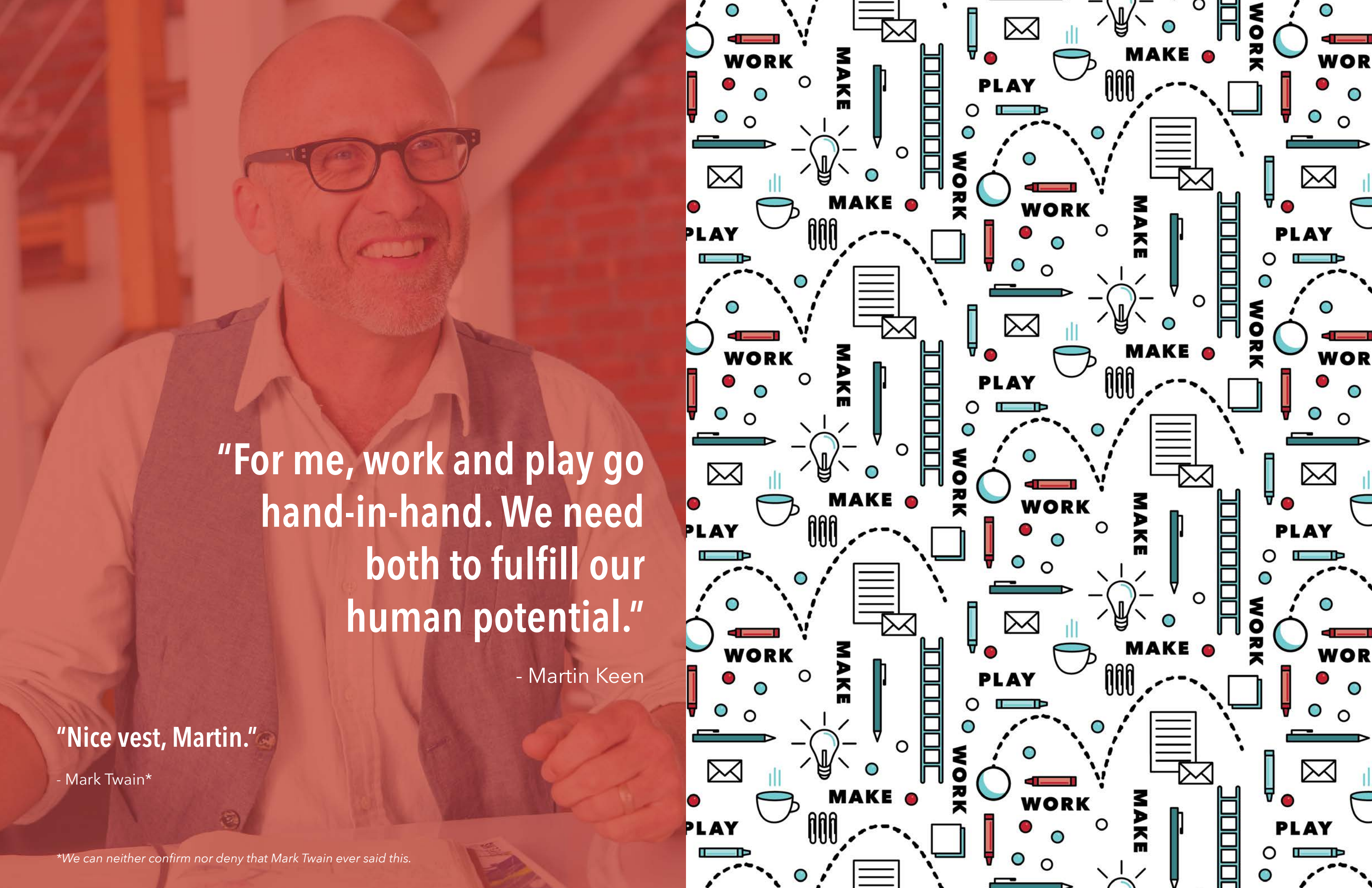

**"For me, work and play go
hand-in-hand. We need
both to fulfill our
human potential."**

- Martin Keen

"Nice vest, Martin."

- Mark Twain*

**We can neither confirm nor deny that Mark Twain ever said this.*



www.focalupright.com

112 Dillabur Ave • North Kingstown, RI • 02852 • 888-266-1011